

Mounting instructions for „Multifunctional trainer basic“

Item-No. 55 1009 401



Diagram 1: Overall view of the fitness equipment

Mounting instructions for „Multifunctional trainer basic“

Item-No. 55 1009 401

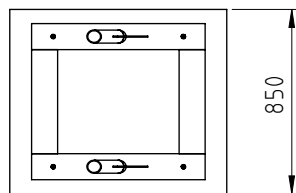
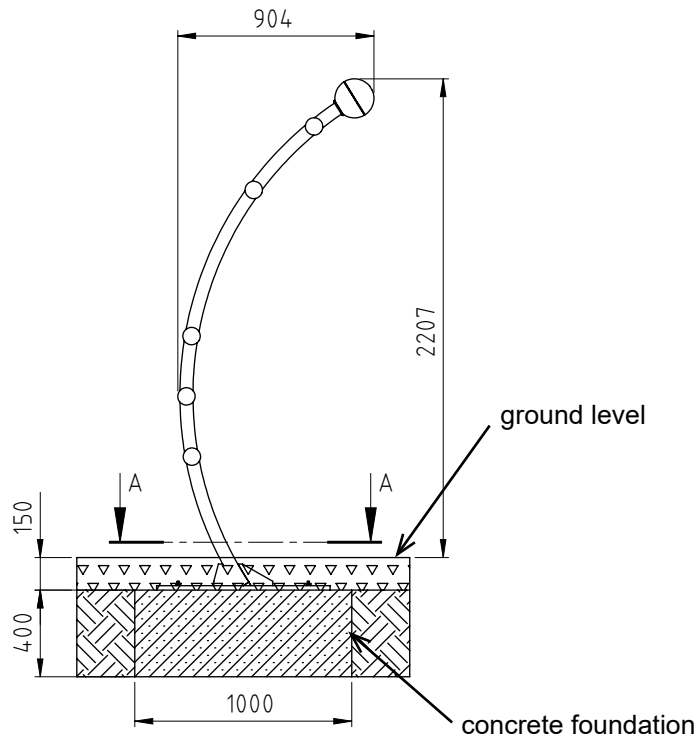

Legende



-  stoßdämpfender Boden
shock-absorbing floor
-  Beton
concrete
-  gewachsenes Erdreich
natural ground

Diagram 2: Foundation plan

1. Select the fitness equipment location in consideration of the required movement area (see diagram 3).
2. Select the position of the instruction sheet.
Attention: Because of the risk of injury, the instruction sheet has to be arranged outside of the movement area.
3. Carry out excavation work for the foundation as shown in diagram 2. After excavation compress the foundation floor.
Note: The fitness equipment is installed at ground level. Pay attention to items marked „ground level“ at fitness equipment.
4. Carry out excavation work for the instruction sheet foundations as shown in diagram 4. After excavation, compress the foundation floor.
5. Set up the concrete foundations according to diagram 2 and diagram 4 with central, horizontal reinforcement.

Reinforcement plan: Concrete foundation with reinforcement

Foundation: BSt 500S
Stirrups \varnothing 8 mm lengthwise and cross
Concrete cover $h' = 3$ cm
Concrete quality class C20/25

6. After a setting period of 10 – 14 days, depending on weather conditions and foundation size, fill up and compress the holes between the foundation and the foundation hole with excavation.
7. Clean the foundation surface. Place the fitness equipment on the foundation and screw the base plates to the foundation using the included heavy-duty dowels.
8. Place the instruction sheet as well to the foundations and screw it to the foundations with the included heavy-duty dowels.
NOTE: We suggest to align the instruction sheet with the result that the instructions are visible during the use of the fitness equipment.

Mounting instructions for „Multifunctional trainer basic“

Item-No. 55 1009 401

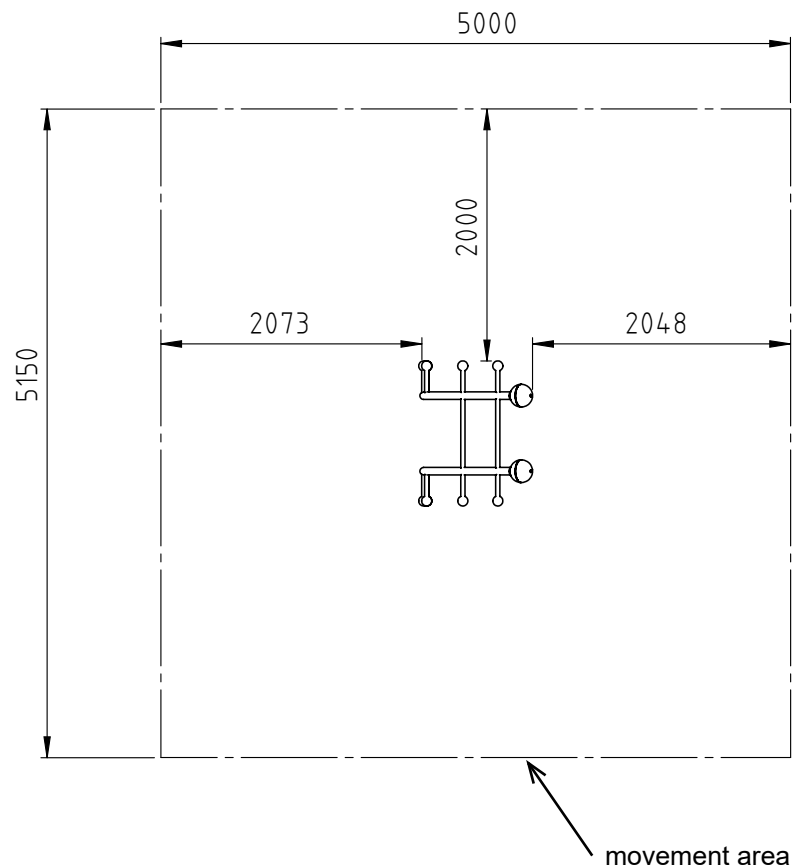

Diagram 3: Top view

9. Cover the movement area with fall protection according to the required drop height in accordance with EN 16630.
Critical drop height: 2000 mm
Recommended surface material: synth. impact protection.
10. The foundation of one-mast equipment has to be accessible for regularly inspection.
11. Do not allow to use the equipment before the installation has been finished.

Attention: If the fitness equipment has been incompletely installed or partly dismantled when carrying out maintenance and repair work, this may lead to particular risks of injury for the user. For this reason, make clearly visible that the equipment shall not be used in such cases.

NOTE: Fitness equipment, which contain components made of stainless steel should not come with „normal“ steel parts in contact. Those steel parts may rub off and leave small steel particles in combination with moisture brown rust stains. If such corrosion occur on stainless steel parts, they are fine to remove with an abrasive (240 grit).

Please take care when transporting and setting up the fact that the components are made of stainless steel with no „normal“ steel parts in contact.

In order to preserve a good visual appearance of your stilum fitness equipment over a long period one should take care of maintenance of the stainless surface even despite of their corrosion resistance.

Especially areas, which can not be reached by rainfall should be frequently cleaned from dirt and deposits due to air pollution and dirt caused by the atmosphere. Light soiling can easily be removed by using a high pressure cleaner. For persistent deposits use a clean cloth moistened with a special liquid cleaner (e.g. on phosphoric acid) and rinse off with clear water after a short application time. During cleaning with mild abrasive components, only wipe over stainless steel surface in polishing direction.

Mounting instructions for „Multifunctional trainer basic“

Item-No. 55 1009 401

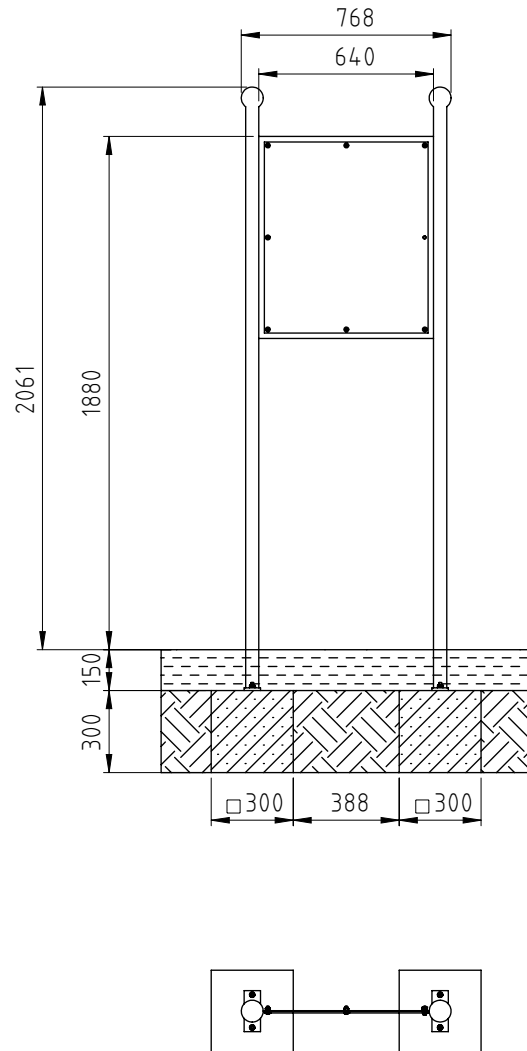

Legende





-  stoßdämpfender Boden
shock-absorbing floor
-  beliebiger Boden
optional floor
-  Beton
concrete
-  gewachsenes Erdreich
natural ground

Diagram 4: Foundation plan of the instruction sheet

For heavily soiled surfaces, polishes can be used (e.g. for cleaning chrome on cars) or for greasy and oily dirt alcoholic cleaning agents and solvents (e.g. ethyl alcohol, isopropyl alcohol or acetone).

However, it should be noted that the dissolved soiling is not spread over the surface again.

Do not use any chlorid or hydrochloric containing cleaning products nor scouring powder, bleaching - or silver polish cleaner. Cleaning intervals depend on type and degree of soiling as well as on demands made on optical characteristics. Therefore cleaning is advisable at intervals of six to twelve months – whereby in the case of strong soiling it is appropriate to clean the fitness equipment at intervals of three to six months.

General Information DIN 16630:2015-06 4.1:

DIN EN 1176 specifies that fitness equipment should not be installed in the immediate vicinity of children's playground equipment. In cases where they are erected in playgrounds or similar establishments near children's playground equipment, they must be separated by adequate distance, fencing or other structural means from the general play zone.

Movement area DIN 16630:2015-06 4.3.14.4

The free space allowed as movement area must be a minimum of 2.2m. The movement area must be clear of fences, and observers should not wait in this space. The space should be free of all objects that the user could fall on and be injured. E.g. injuries could be caused by posts that are not flush with adjacent parts or by protruding footings. In cases where the equipment has a forced movement, the free area must be extended about 0.5m. Where fitness units are installed on or adjacent to a wall which is at least as high as the exercise space, the movement area may be reduced. Movement areas of adjacent equipment may overlap except for equipment with forced movement.